

# CRYSTAL LAKE LAKE MANAGEMENT PLAN

MATANUSKA-SUSITNA BOROUGH  
PLANNING DEPARTMENT

Adopted August 1996

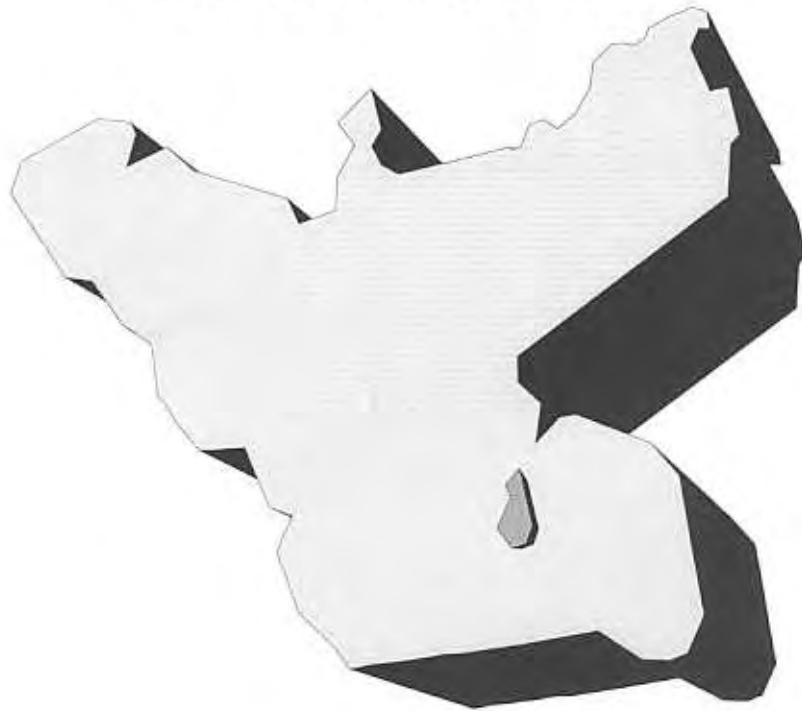

Code Ordinance

By: D. Moore  
Introduced: 7/16/96  
Public Hearing: 8/6/96  
Adopted: 8/6/96

**MATANUSKA-SUSITNA BOROUGH  
ORDINANCE SERIAL NO. 96-097**

AN ORDINANCE OF THE MATANUSKA-SUSITNA BOROUGH ASSEMBLY ADOPTING MSB  
15.24.030(C)(8), THE CRYSTAL LAKE, LAKE MANAGEMENT PLAN.

WHEREAS, the Crystal Lake, Lake Management Plan provides guidelines for the management of Crystal Lake; and

WHEREAS, the management guidelines for Crystal Lake were developed with input from the residents and property owners of Crystal Lake; and

WHEREAS, the residents and property owners of the Crystal Lake area are concerned about unsanitary conditions, loss of wildlife and wildlife habitat, and the lake's water level; and

WHEREAS, the residents and property owners of the Crystal Lake area have developed a set of management guidelines to protect the public health, safety and welfare; and

WHEREAS, the residents and property owners of the Crystal Lake area have developed a set of management guidelines to protect the lake's environment and wildlife; and

WHEREAS, the Crystal Lake, Lake Management plan provides for the public's continual access, use, and enjoyment of Crystal Lake; and

WHEREAS, the Matanuska-Susitna Borough Planning Commission has recommended approval of the Crystal Lake, Lake Management Plan.

BE IT ENACTED:

Section 1. Classification. Sections 1, 2, and 4 are non-code; section 3 is of a general and permanent nature and shall become part of the borough code.

Section 2. Approval of plan. The Matanuska-Susitna Borough Assembly does hereby adopt the Crystal Lake, Lake Management Plan.

Section 3. Amendment of subsection. MSB 15.24.030(C) is hereby amended to add a paragraph (8) to read:

(8) Crystal Lake, Lake Management Plan, May 1995,  
adopted 1995.

Section 4. Effective date. Ordinance Serial No. 96-097 shall take effect upon adoption by the Matanuska-Susitna Borough Assembly.

ADOPTED by the Matanuska-Susitna Borough Assembly this 6th day  
of August, 1996.



---

BARBARA LACHER, Borough Mayor

ATTEST:



---

SANDRA A. DILLON, Borough Clerk

(SEAL)

MATANUSKA-SUSITNA BOROUGH  
PLANNING COMMISSION RESOLUTION NO. 96-23

A RESOLUTION OF THE MATANUSKA-SUSITNA BOROUGH PLANNING COMMISSION  
RECOMMENDING THAT THE ASSEMBLY ADOPT THE CRYSTAL LAKE, LAKE  
MANAGEMENT PLAN

---

WHEREAS, the Crystal Lake, Lake Management Plan was developed with input from the residents and property owners of Crystal Lake; and

WHEREAS, the residents and property owners of the Crystal Lake area are concerned about unsanitary conditions, loss of wildlife and wildlife habitat, noise, erosion and protection of the quiet residential character of the Lake; and

WHEREAS, the residents and property owners of the Crystal Lake area have developed a set of management guidelines to protect the public health, safety and welfare; and

WHEREAS, the residents and property owners of the Crystal Lake area have developed a set of management guidelines to protect the Lake's environment and wildlife; and

WHEREAS, the Crystal Lake, Lake Management plan provides for continued public access, use and enjoyment of Crystal Lake.

NOW THEREFORE BE IT RESOLVED, that the Planning Commission of the Matanuska-Susitna Borough recommends that the Assembly adopt the Crystal Lake, Lake Management Plan.

ADOPTED by the Matanuska-Susitna Borough Planning Commission this 15<sup>TH</sup> day of April, 1996.



Timothy L. Anderson  
Chairman

ATTEST



Nancy Trimble  
Planning Clerk

(SEAL)

# Table of Contents

	Page
1. Introduction	1
1.1 Purpose	1
1.2 Approaches to Lake Management	1
1.3 Process	2
1.4 Ponds, Lakes, and Reservoirs	3
1.5 Lake Lifespan	3
1.6 General Lake Issues and Concerns	4
1.7 Crystal Lake Issues and Concerns	5
2. Inventory of Existing Conditions	5
2.1 Location	5
2.2 Land Ownership	5
2.3 Existing Plans	6
State	6
Borough	6
2.4 Existing Regulations	7
Federal	7
State	7
Borough	8
Private	10
2.5 Present Lake Usage	10
3. Goals	11
3.1 Water Quality	11
3.2 Recreation and Residential Character	11
3.3 Wildlife	12
3.4 Access	12
4. Management Issues, Alternatives, and Recommendations	12
4.1 Access	12
4.2 Wildlife	13
4.3 Noise	14
5. Implementation	15

## List of Figures

Figure 1: Location Map

Figure 2: Willow Community Council Boundary and Planning Area

Figure 3: Land Ownership

Figure 4: Transportation Corridors

Figure 5: General Setback Requirements and Lot Size Requirements

Figure 6: Crystal Lake Bathymetric Map

## List of Tables

Table 1: Crystal Lake Characteristics

Appendix #1: Bird nesting area buoys, Loon Alert! and Steer Clear! posters

Public Comment Sheet

# 1 Introduction

## 1.1 Purpose

Lake management plans are developed for a variety of purposes. Most often lake front property owners request management plans because increased development or the provision of new public access brings about increased lake usage and a corresponding increase in user conflicts. As more people use a lake, conflicts among users may occur, bird nesting sites (especially loons and grebes) may be disturbed, environmental degradation may occur, and the overall quality of the experience may decline. The most often cited complaints are noise generated from watercraft during the evening and night hours and inappropriate use of public access points. A lake management plan seeks to present policies and strategies which attempt to balance the various demands placed upon a lake, solve lake related problems, and protect the public health, safety, and welfare.

The Crystal Lake, Lake Management Plan provides management guidelines for:

- o The protection of the residential quality of life at Crystal Lake; and
- o The continued recreational enjoyment of Crystal Lake; and
- o The protection of Crystal Lake's water quality; and
- o The provision of managed and maintained access; and
- o The protection and enhancement of fish and wildlife; and
- o The protection of the public health, safety, and welfare.

## 1.2 Approaches to Lake Management

There are two approaches that residents and property owners of the Matanuska-Susitna Borough may use to address lake related issues. One approach is to initiate a petition as authorized by 17.58 of the Borough Code. This ordinance, which was adopted by voter initiation in 1994, allows members of the public to either prohibit all motorized use on a waterbody or to establish quiet hours (11 p.m. to 8 a.m.), a 100 foot no wake zone from the shoreline, requirement of mufflers on all piston driven engines, and allows special events by permit. Once a petition is filed, a report is drafted by the Planning Department regarding the suitability of the ordinance for the lake in question and public hearings are then held on the matter by the Planning Commission and Assembly. Since this ordinance was adopted by voter initiative it may not be amended for a period of two years. As of April, 1995 this ordinance is in effect for Wasilla, Cottonwood, Mud, and Finger lakes while all motorized use is prohibited on Cottonwood Creek.



The other approach that may be utilized for managing a lake is a lake management plan. A lake management plan is developed with the input of local property owners and residents. The Borough Planning Department assists the planning effort by collecting background information, developing maps, etc., but it is the property owners and residents who decide policy issues and develop goals and recommendations. The management planning process also allows a more comprehensive approach to addressing lake related concerns. The lake management planning process allows property owners and residents to tailor management guidelines to their particular needs and desires.

### 1.3 Process

Lake management plans are typically initiated by individuals having concerns about a particular lake or who have experienced conflicts between user groups. These individuals request that the Planning Department of the Matanuska-Susitna Borough complete a lake management plan. With the concurrence of the Planning Commission which is vested with planning authority in the Borough, the Department collects background information on the lake and contacts adjacent property owners and users to participate in the planning process.

Meetings are held with adjacent property owners and users to: 1) identify any problems that may exist, 2) develop recommended alternatives, and 3) consider methods of implementing the recommendations. A draft plan is then developed and a public comment period is held to solicit comments on the draft plan. After the public comment period is closed, comments are reviewed and appropriate modifications made. A meeting may be held with adjacent property owners and users to discuss the comments and proposed modifications. Whether or not this meeting is held depends on the comments received; if the comments call for minor changes or none at all, a meeting is not likely to occur. On the other hand, if the comments seek major changes to the draft plan, a meeting is arranged to discuss the comments and proposed modifications.

After the draft plan has been reviewed by the public, a public hearing on the plan is scheduled with the Borough Planning Commission. At the public hearing anyone may comment on the plan. The Commission considers all oral and written comments received and either recommends to the Assembly adoption of the plan as is or with modifications, or recommends Assembly disapproval of the plan. After Planning Commission action, the plan is scheduled for a public hearing by the Assembly. The Assembly considers all oral and written comments received and either adopts the plan as is or with modifications, or disapproves the plan.



#### 1.4 Ponds, Lakes, and Reservoirs<sup>1</sup>

There are no scientific definitions of the terms **lake**, **pond**, and **reservoir**. In general, waterbodies which have a noticeable flow are termed either rivers or streams. "Ponded waters" have little or no current compared with rivers and streams.

A pond is usually described as a small, shallow body of water, with uniform water temperature from top to bottom. There is little wave action, and often, an abundance of aquatic plants. Although local definitions may vary, a pond is generally less than ten acres in area and ten feet in maximum depth.

A lake is usually larger than a pond. It may be quite large and deep, with an abundance of cold water at the bottom. It also may exhibit areas of rocky, wave-impacted shoreline as a result of exposure to prevailing winds. The area of land around the lake which contributes water to the lake is the **watershed**. The watershed may be large or small when compared to the area of the lake. The water may enter the lake from the watershed as streams and rivers, or through the ground as groundwater. The term watershed is used interchangeably with **catchment** or **drainage basin**, although the latter term can imply a larger area containing several watersheds or **sub-basins**. The boundaries of a watershed are defined by ridges and hills that divide or separate water movement into one drainage basin or another. The **lake basin** includes the lake bottom as well as the surrounding slopes.

#### 1.5 Lake Lifespan<sup>2</sup>

Lakes fill in, drain themselves, or just evaporate and disappear. They do not last forever. Although lakes seem permanent in our human time perspective, they are sediment traps, and it is natural for them to fill in gradually with sand, silt, and organic matter. Natural lake aging or **eutrophication** moves from a nutrient-poor (**oligotrophic**) condition to an intermediate (**mesotrophic**) stage of nutrient availability and biological productivity, and finally to a nutrient-rich or highly productive (**eutrophic**) state. Eutrophication - the process of nutrient enrichment and basin filling - may take thousands of years, but it can be accelerated greatly by disruptions to the watershed. Human activities that increase nutrient and sediment loadings to a lake are termed **cultural eutrophication** and include forest clearing, road building, construction, and wastewater discharges.

---

<sup>1</sup> This section is taken from Diet For A Small Lake, Prepared by the New York State Department of Environmental Conservation and the Federation of Lake Associations, Inc., 1990.

<sup>2</sup> This section is taken from Diet For A Small Lake, Prepared by the New York State Department of Environmental Conservation and the Federation of Lake Associations, Inc., 1990.

Trophic conditions in lakes are relative, not absolute - that is, there is no definitive line between oligotrophic and mesotrophic, or between mesotrophic and eutrophic. However, each trophic state has characteristic conditions. Oligotrophic lakes have a low level of organic productivity, clear water, and low nutrient levels. These lakes often are characterized by deep water and steep basin walls. Water in mesotrophic lakes contains a moderate supply of nutrients and organic production. Eutrophic lakes are characterized by a very high level of nutrients which causes a significant increase in the rate of plant growth. As a result, water clarity is greatly reduced, and oxygen depletion is common during the summer months. Eutrophic lakes tend to be shallow and, typically, have elevated water temperatures.

Identification of a lake's trophic status is a useful way to determine its general "health", or biological status, from one year to the next and in comparison with other lakes. If a potential problem is identified in a lake, the trophic status can also be used to evaluate management alternatives.

A few lakes are naturally eutrophic. Many lakes and reservoirs are located in naturally fertile watersheds where the soil is highly erodible. Unless the soil remains undisturbed, these lakes have little chance of being anything but eutrophic. Users of these lakes need to recognize and accept the fact that manmade systems (such as laws, property, or zoning) may not "correct" the conditions. Residents and visitors should adjust their expectations for the appearance and use of such eutrophic lakes.

#### 1.6 General Lake Issues and Concerns

This section describes some of the most common concerns and issues that have been raised by residents and property owners of the Borough. There are three main categories of lake related concerns and issues. One category is water quality related. Activities within the shoreland area can have a direct impact on lake water quality. A shoreland is the land within 500 to 1,000 feet of the normal mean water mark of a lake or pond. The placement of septic systems in unsuitable soils or too close to the lake or the lack of sanitary facilities at public access points can introduce nutrients and pathogens into the lake. Inadequate soil erosion control during upland construction can increase the loading sediment to the lake. Removal of vegetation along the shoreline or at unsupervised public access points may increase erosion of the bank and loss of its ability to filter runoff.

Another category of concerns and issues is related to the surface use of the lake. Some uses may conflict with one another such as fishing and water-skiing because it is difficult for both activities to occur at the same time and in the same location. Other uses cause conflicts by the nature of how the use occurs such as becoming a nuisance by creating noise during sleeping hours. Some uses of the

surface water may create shoreline erosion and hence, sediment loading at the lake and loss of private property.

The last category of lake issues regards the impact of recreational use on wildlife and wildlife habitat. Unsuccessful nesting or above average mortality may occur during the nesting season if nests are harassed, frequented by watercraft, or swamped by wave action.

## 1.7 Crystal Lake Issues and Concerns

The Crystal Lake, Lake Management Plan was initiated by a request from Crystal Lake property owners. A meeting was held with residents and adjacent property owners. At this meeting concerns and issues were discussed.

The issues identified included:

- 1) Noise (summer only); and
- 2) Boating safety; and
- 3) Protection of the wildlife and wildlife habitat; and
- 4) Lack of appropriate facilities at the public access which has caused unsanitary conditions.

It is the desire of the majority of property owners and residents of Crystal Lake that the recreational use and residential character of the lake be protected. The present state of the lake may be characterized as residential, quiet, with active loon and grebe nests. However, trash and unsanitary conditions, primarily associated with the public access land to the lake, is a concern, as is the desire for quiet times during the evening hours during the summer months. While the use of personal watercraft is not presently a problem, some residents and property owners are concerned that this use may become a problem in the future.

## 2 **Inventory of Existing Conditions**

### 2.1 Location

Crystal Lake is located approximately 2.5 miles west of the George Parks Highway at milepost 67 and is part of the greater Willow community (see Figure 1). Crystal Lake is accessed by Long Lake Road. The Crystal Lake area is located completely within the boundaries of the Willow Community Council (see Figure 2).

### 2.2 Land Ownership

There are 58 lots fronting on Crystal Lake. All parcels of the land adjacent to Crystal Lake are privately owned. The Borough owns one parcel of land which is an island (see Figure 3).

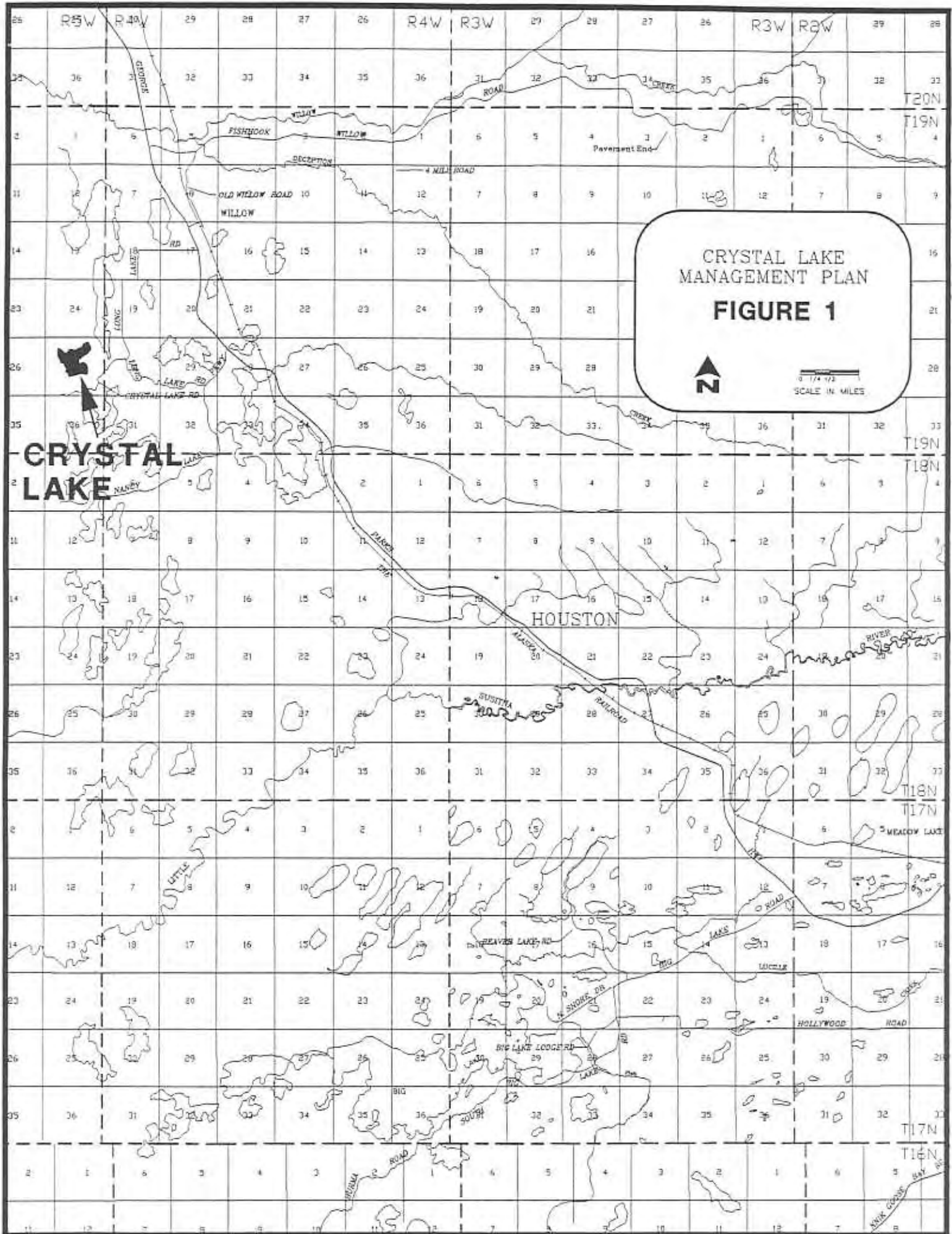

CRYSTAL LAKE  
MANAGEMENT PLAN  
FIGURE 1



# WILLOW COMMUNITY COUNCIL

Figure 2

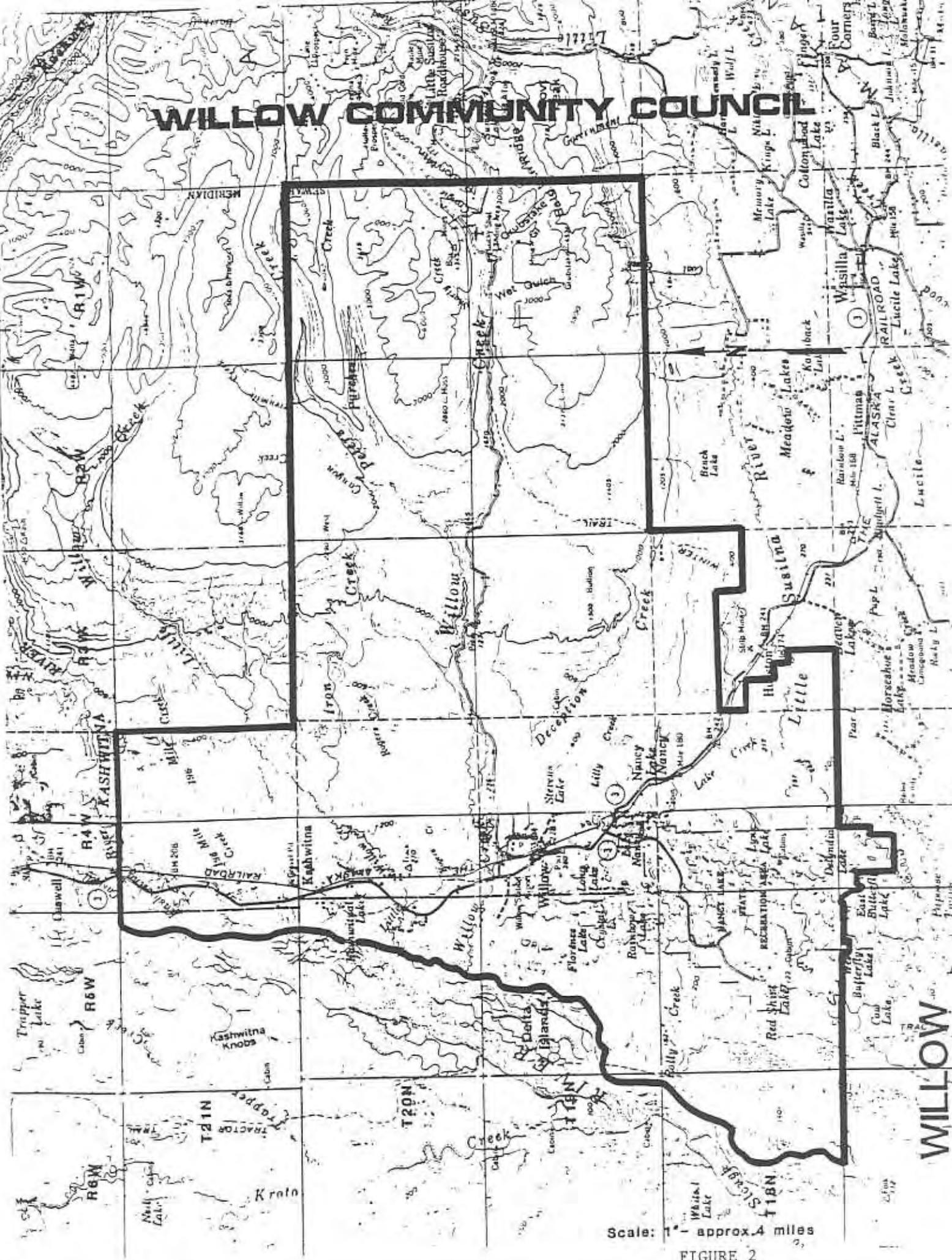

Scale: 1" = approx. 4 miles

FIGURE 2

WILLOW

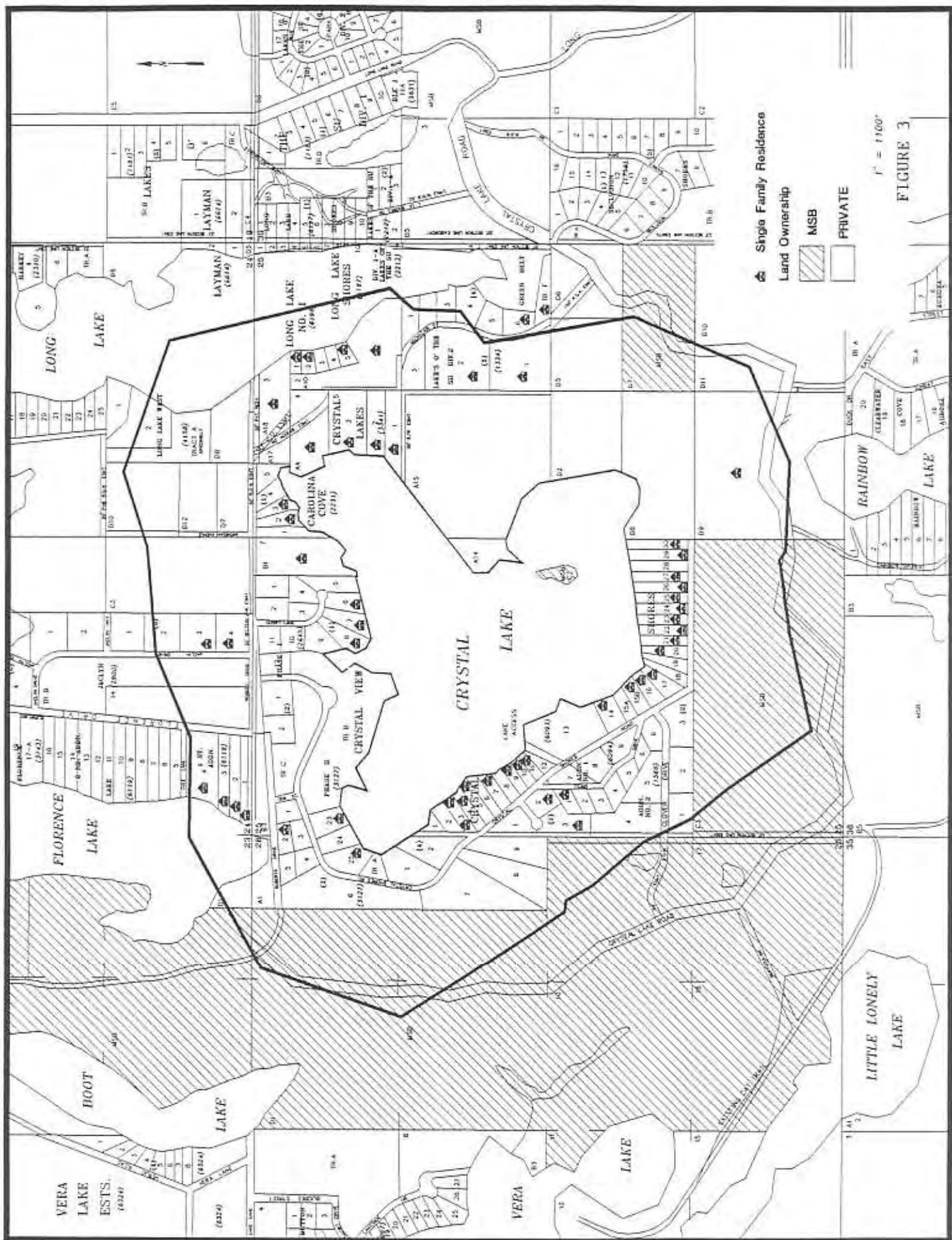

Single Family Residence  
 MSB  
 PRIVATE  
 Land Ownership

1" = 1100'

FIGURE 3

## 2.3 Existing Plans

### State

The State plan affecting the Crystal Lake area is the Willow Sub-Basin Plan. The Willow Sub-Basin Area Plan, adopted in October 1982, contains management intent for State and Borough lands within the Willow Sub-Basin, an area of approximately 1,500 square miles. Crystal Lake is located within the Willow management unit. Generally speaking, the plan's intent for public lands within the management unit is to provide lands to support community land needs of the Willow community and the capital site. Borough lands are to be considered for agriculture and forestry purposes. Lands along the George Parks Highway are to be used to protect the highway's scenic quality.

### Borough

Borough plans that address Crystal Lake in some manner include the Borough-wide Comprehensive Plan, adopted in 1971; the Matanuska-Susitna Borough Coastal Zone Management Plan, as amended; and the Borough-wide Long Range Transportation and Public Facilities Plans.

The Borough-wide Comprehensive Plan does not make specific recommendations for either the Crystal Lake or Meadow lakes areas. Rather, the 1971 plan recognizes that the Meadow Lakes area has important recreational characteristics and that these characteristics will attract visitors and new residents in the future<sup>3</sup>.

Crystal Lake lies within the Matanuska-Susitna Borough Coastal District (District), as defined within the Matanuska-Susitna Borough Coastal Management Plan, as amended. The Coastal Management Plan seeks to direct the course of local, state, or federal development within the District in a manner that protects the important land and water resources of the District. The adopted policies of the Coastal Management Plan are used to evaluate development proposals vis-a-vis resource values in an effort to ensure that the proposals are consistent with the plan's goals and objectives. Local development includes actions that trigger a Borough subdivision, planning, or zoning action. For example, a variance application to build a habitable structure or garage closer than 75 feet from the ordinary high water mark of Crystal Lake would be reviewed to determine whether or not it is consistent with the Coastal Zone Management Plan. Construction within waterbodies are also reviewed for consistency with the plan. Uncovered floating or pile supported docks which do not extend more than 40 feet beyond the ordinary high water line and do not exceed 400 square feet in size

---

<sup>3</sup> Alaska State Housing Authority, Matanuska-Susitna Borough Comprehensive Development Plan, Phase II: Recommendations, 1970.



may obtain a general concurrence. Metal drums, however, may not be used as floatation devices.

The Borough Long Range Transportation Plan was adopted in 1987 and is presently being updated. The plan identifies two road corridors in the vicinity of Crystal Lake, Susitna River Road, and West Long Lake Access (see Figure 4). Neither of these roads are presently scheduled for construction.

The Borough Public Facilities Plan makes recommendations on a regional basis for the provisions of public services including the development of public facilities necessary to the provision of those services. Services included in the plan include: public safety (fire protection, emergency medical services, and emergency preparedness); library; historical preservation; governmental administration; education; parks, recreation and open space; trails; and utilities. All of these elements affect the Crystal Lake area in some way, but the Parks, Recreation and Open Space; and Trails elements would have the most impacts relative to the concerns of this management plan.

#### 2.4 Existing Regulations - Public

This section describes the principle regulations affecting use and development in the Crystal Lake area. This section is **NOT** meant to provide an all encompassing description of all activities and uses that require permits or approvals from local, state, or federal agencies. Prior to undertaking any development activity, individuals should contact the appropriate local, state, and federal agencies and obtain the required permits and approvals.

##### Federal

Any work which results in the dredging or placing of structures or fills in tidal (ocean) waters, streams, lakes, or wetlands requires a 404 permit from the U.S. Army Corps of Engineers.

Migratory birds, which include loons and grebes, are protected by the Migratory Bird Treaty Act. The Act, among other things, prohibits the "take" of migratory birds where "take" is defined to mean pursuing, killing, etc., migratory birds. Destruction of nest sites, eggs, or the birds themselves is a violation of the Act.

##### State

The Alaska Department of Environmental Conservation (DEC) provides regulations for waste water disposal. DEC wastewater/septage regulations [18 AAC 72,015(f)] state that no holding tank, septic tank, soil absorption system, seepage pit, privy, or other waste water collection, treatment, or disposal system may be within 100 feet, measured horizontally, of the mean annual high

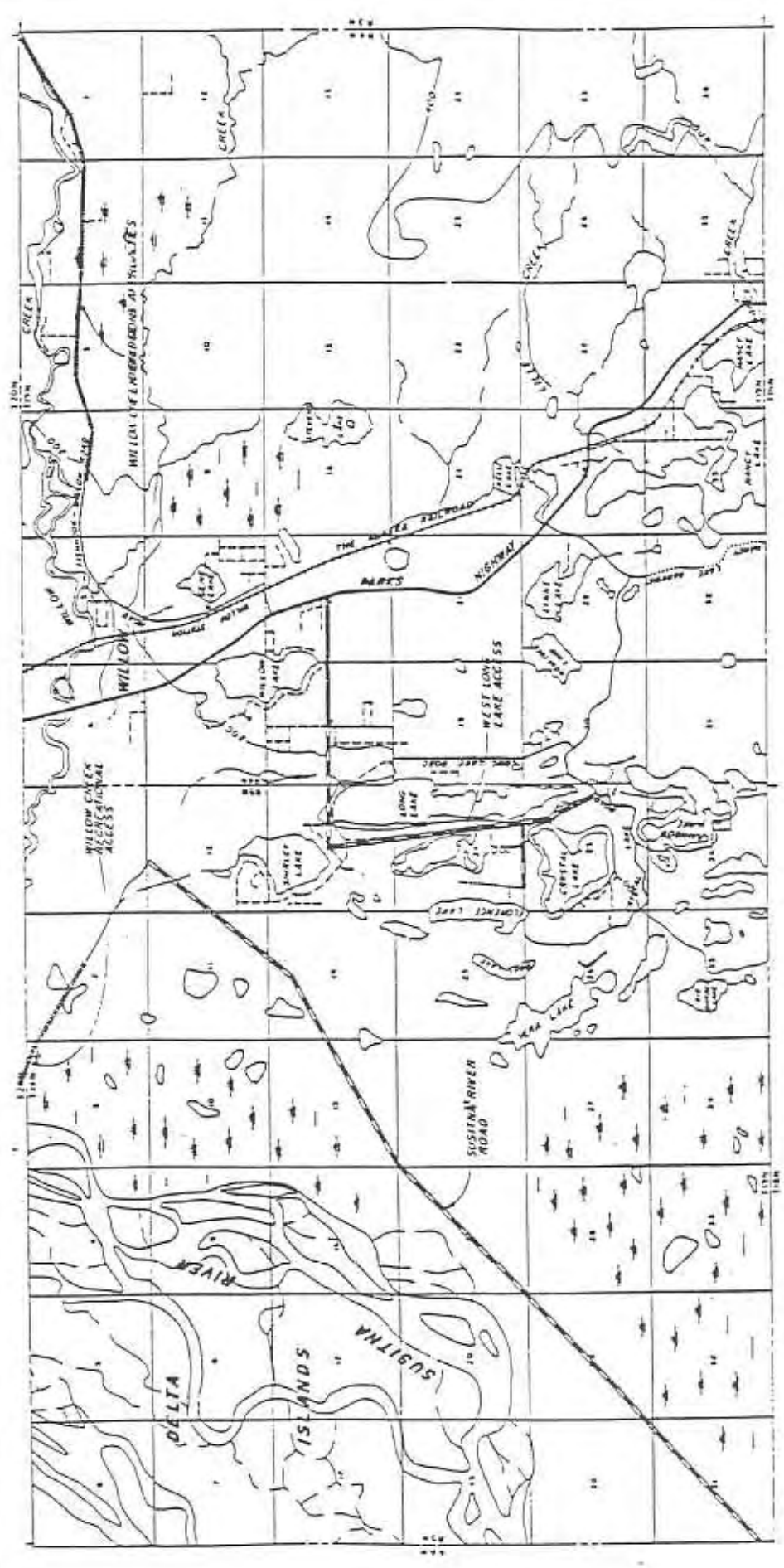

**ROADWAY CLASSIFICATION/  
TRANSPORTATION  
PLAN**  
Project No. 1314  
 SM19/4-DW  
**MATANUSKA SUBITNA BOROUGH**



**LEGEND:**

[Symbol]	WILSON CREEK ACCESS	[Symbol]	WILSON CREEK
[Symbol]	WILSON CREEK ACCESS	[Symbol]	WILSON CREEK
[Symbol]	WILSON CREEK ACCESS	[Symbol]	WILSON CREEK
[Symbol]	WILSON CREEK ACCESS	[Symbol]	WILSON CREEK
[Symbol]	WILSON CREEK ACCESS	[Symbol]	WILSON CREEK
[Symbol]	WILSON CREEK ACCESS	[Symbol]	WILSON CREEK
[Symbol]	WILSON CREEK ACCESS	[Symbol]	WILSON CREEK
[Symbol]	WILSON CREEK ACCESS	[Symbol]	WILSON CREEK
[Symbol]	WILSON CREEK ACCESS	[Symbol]	WILSON CREEK
[Symbol]	WILSON CREEK ACCESS	[Symbol]	WILSON CREEK
[Symbol]	WILSON CREEK ACCESS	[Symbol]	WILSON CREEK

FIGURE 4

water level of a lake, river, stream, spring, slough, or the mean higher high water level of coastal waters.

In addition to the U.S. Army Corps of Engineers 404 permit requirements, any activity within streams and certain work within lakes requires a Title 16 permit from the Department of Fish and Game. Activities which result in the construction of a dam which impounds water or places a weir, culvert, or temporarily blocks a stream requires a Title 16 permit. In February, 1994 the Habitat and Restoration Division of Fish and Game issued a one year, general permit allowing the vehicle movement on frozen water surfaces in southcentral Alaska. The permit allows certain motorized vehicles less than 2,000 pounds gross vehicle weight and wheeled vehicles less than 10,000 pounds gross vehicle weight to travel upon frozen water surfaces in southcentral Alaska without a special permit. Finally, the general Alaska Department of Fish and Game fishing regulations apply to Crystal Lake.

Navigable and public waters in Alaska have special public access requirements. A navigable or public waterbody includes water suitable for commercial navigation, floating of logs, land and takeoff of aircraft, and public boating, trapping, hunting waterfowl and aquatic animals, fishing, or other public recreational purposes. Crystal Lake meets the definition of a public water body. Alaska statute (AS 38.05.128) requires that the public have access to the surface waters of any navigable or public waterbody of the State. This requirement is typically called a "to" easement. In addition, all navigable and public waterbodies have a 50 foot easement along the water body; this easement is typically called an "along" easement. In regards to the actual ownership of the lands, the boundary between private and public ownership is the ordinary high watermark of a waterbody or watercourse. Therefore, an "along" easement may be used for transportation or emergency landing purposes but not for overnight camping. These easements are created when the State or Borough obtains patents to their lands and continue with the property when either entity disposes of lands.

### Borough

Several Borough-wide ordinances address the development and use of land adjacent to Crystal Lake. The regulations are contained within the Borough's planning (Title 15), subdivision (Title 16), zoning (Title 17), and real property management (Title 23) ordinances. The adopted Coastal Management Plan described earlier, because of its enforceable criteria, also regulates development activities within and near Crystal Lake.

Title 15 establishes and describes the general functions of the Planning Commission (both planning and zoning functions) and the Board of Adjustment and Appeals. Title 15 also describes the comprehensive plan and purposes. Once adopted, the Crystal Lake, Lake Management Plan will become an instrument of Borough policy similar to the other plans adopted by the Borough Assembly.

Title 16 provides the subdivision development standards within the Borough and establishes the Platting Board. Two of Title 16's requirements that are of special note to development at Crystal Lake include a minimum lot size of 40,000 square feet, and a minimum lot width, when measured at the lake's water line, of one hundred twenty-five feet unless community septage is provided, then the minimum width may be eighty-five feet (see Figure 5).

The Borough has a Borough-wide comprehensive plan which is implemented, in part, through the Borough-wide zoning ordinance. Presently, the Borough undertakes its comprehensive planning on a community by community basis. As most comprehensive plans are implemented through a zoning ordinance, a number of different zoning ordinances exist within the Borough and are identified as Special Use Districts. For example, the cities of Houston, Palmer, and Wasilla all have their own comprehensive plans and all have zoning ordinances unique to their cities. Title 17 contains these various zoning ordinances of the Borough. A list of Title 17's chapters follows.

- 17.01 Acknowledgment of Existing Land Use Regulations.
- 17.03 Public Notification.
- 17.04 Nancy Lake State Recreation Area Special Land Use District.
- 17.08 Hay Flats Recreation Area Special Land Use District.
- 17.15 Palmer Special Land Use District.
- 17.17 Denali State Park Special Land Use District.
- 17.18 Chickaloon Special Land Use District.
- 17.19 Glacier View Special Land Use District.
- 17.29 Flood Damage Prevention.
- 17.36 Residential Planned Unit Development.
- 17.40 Houston Land Use Ordinance.
- 17.45 Wasilla Special Use Land District.
- 17.48 Mobile Home Park Ordinance.
- 17.52 Residential Land Use District.
- 17.55 Setbacks and Screening Easements.
- 17.56 Violations and Enforcement.
- 17.58 Motorized Uses on Lakes and Waterways.
- 17.60 Conditional Uses.
- 17.65 Variances.
- 17.70 Regulation of Alcoholic Beverage Uses.
- 17.80 Nonconforming Structures.
- 17.90 Regulation of Adult Businesses.
- 17.99 Fees.

Zoning regulations that are of special note to development activities at Crystal Lake include setback requirements and a petition process to limit or eliminate motorized use of lakes and conditional use permits. Presently all structures must be a minimum of twenty-five feet from a right-of-way and ten feet from all lot

Figure 5

# General Setback Requirements and Lot Size\* Requirements

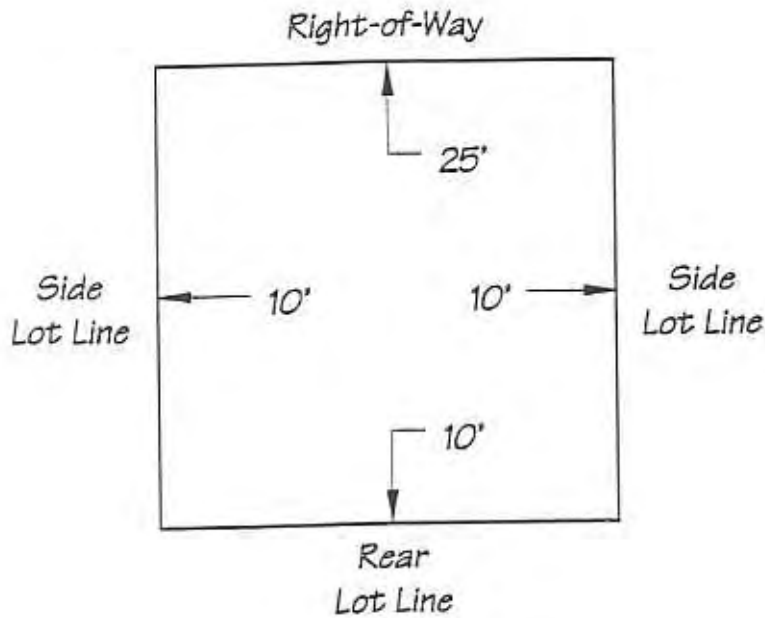

Ordinary High Water Line  
of Lake (no community septage)

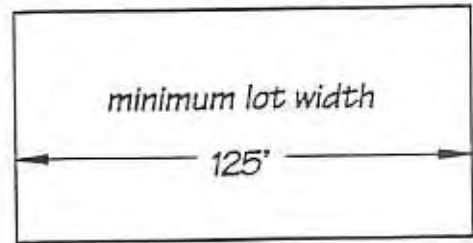

Ordinary High Water Line  
of Water Body or Watercourse

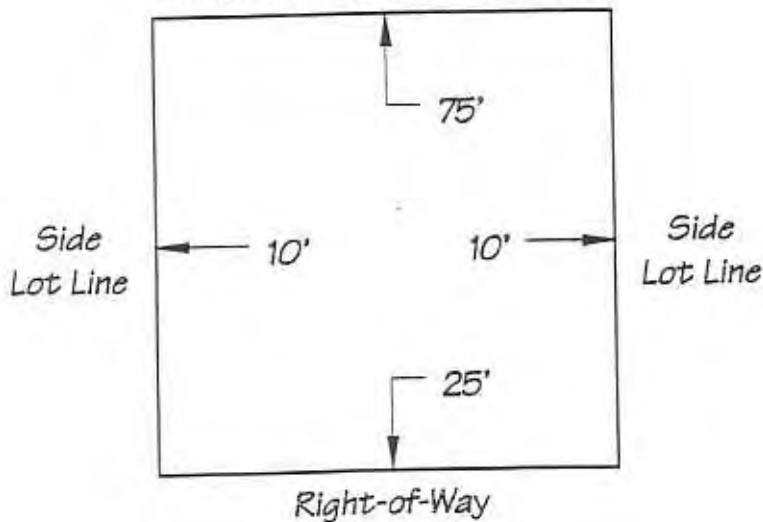

Ordinary High Water Line of  
Lake (community septage available)

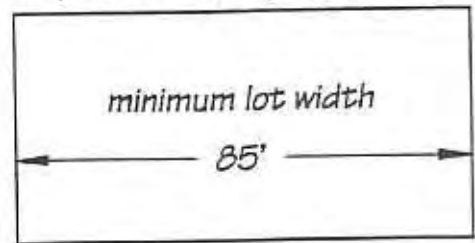

\*All lots must be a minimum of 40,000 sq. ft.



lines. In addition, the voters of the Borough approved by initiative, a requirement that all habitable structures and garages must be located at least seventy-five feet from the ordinary high water mark of any waterbody or watercourse (see Figure 4). In 1994, the voters of the Borough also adopted by initiative, an ordinance that allows by petition and subsequent adoption by the Assembly, the following restrictions to be placed on lakes and waterbodies: 1) limiting or elimination of motorized use of lakes, 2) establishment of quiet hours, and 3) establishment of a one hundred foot no wake zone from the ordinary high water mark. The Borough also requires that any development which seeks to establish or operate a mobile home park, junkyard, refuse area or landfill, or dispense alcohol must first obtain a conditional use permit.

The Borough received approximately 350,000 acres of land through the Municipal Entitlement Program. The Planning Department of the Borough manages and disposes of these lands through the policies and procedures described within Title 23. As of December, 1994, the Borough did not own any land within the Crystal Lake area.

#### Existing Regulations - Private

Private regulations or covenants exist in the Crystal Lake area. Carolina Cove Subdivision is limited to residential uses only. Crystal Lake Phases I and II are limited to residential uses only but also have a 75 foot waterbody setback and a provision restricting extensive wetland alteration. Tract "A" of Crystal Lake Subdivision was dedicated to the public for lake access purposes. For current information about covenants in the area, the reader is referred to the State of Alaska Recorders Office.

### 2.5 Present Lake Usage

Crystal Lake contains 132 surface acres with one island and has just over 2.8 miles of shoreline (see Table 1). Figure 6 illustrates the lake's bathymetry. Rainbow trout are found in the lake and the lake contains active grebe and loon nests.

Table 1  
Crystal Lake Characteristics

Surface Area	132 acres
Maximum Depth	24 feet
Mean Depth	11.7 feet
Shoreline Length	2.8 miles
Volume	1,548 acre feet

Source: State of Alaska, Department of Fish and Game

# MATANUSKA-SUSITNA VALLEYS STOCKED LAKES SERIES

State of Alaska  
 Department of Fish and Game  
 Sport Fish Division  
 1800 Glenn Hwy #4  
 Palmer, AK 99645  
 (907) 745-5016

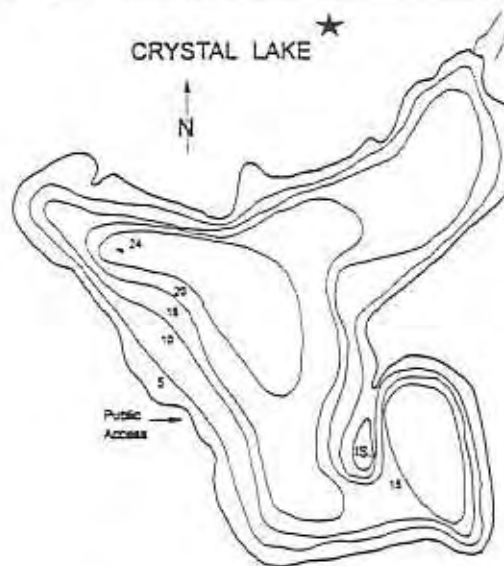
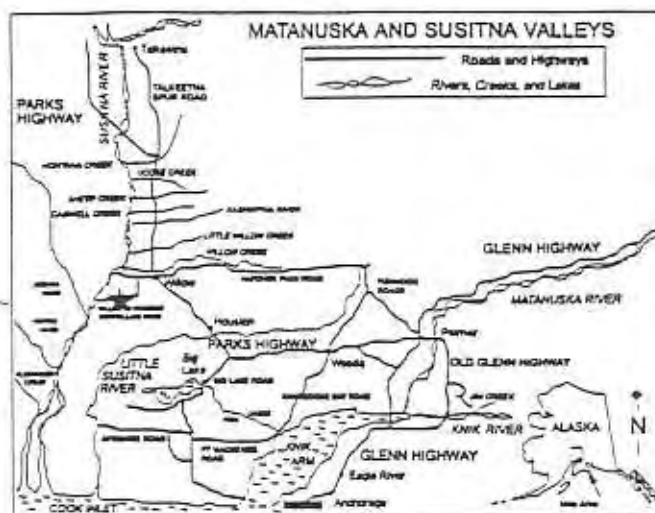

U.S.G.S Map Ref.	Tyonek C-1, T19N, R5W, S25	Geographic Location	61°42'30"N, 150°06'15"W
Elevation	180'	Surface Acres	132
Volume	1,548 Acre Ft.	Maximum Depth	24'
Mean Depth	11.7'	Shoreline Length	2.8 Miles
Surveyed	7/26/82 ADFG	Year 1st Stocked	1963
Game Fish Present	Rainbow Trout		

**CRYSTAL LAKE PUBLIC ACCESS:** Mile 69.2 Parks Hwy. West on Long Lake Rd. 3.4 miles. Stay to the right, road is now Crystal Lake Rd. 0.2 mile on Crystal Lake Road to Crystal Lake Alternate. Right on Crystal Lake Alternate for 1.1 miles to Crystal View Drive. Left on Crystal View Dr. for 0.9 mile to Crystal Lake access with parking and undeveloped boat launch. **NOTE:** Limited public access. Majority of lake shoreline is privately owned. Please respect private property.

FIGURE 6



The present use of Crystal Lake may be characterized as being recreational and the property immediately adjacent to the lake is residential in character. Residents live at the lake throughout the entire year. Lake front property owners are the predominant users of Crystal Lake. They boat, swim, and fish at the lake.

Residents have indicated that the lake is also used by visitors for boating and fishing. Some visitors access the lake from the public access point located on the west side of the lake where a right-of-way connects Crystal Lake to Crystal Shores Road. Some visitors have been reported to camp at the site which lacks sanitary and camping facilities and trash receptacles resulting in unsanitary conditions.

### 3 Goals

Goals describe the future expectations of residents, property owners, and users for a lake. The following goals reflect the aspirations of Crystal Lake residents, property owners, and users and address their principal concerns: water quality, access, wildlife, quality of experience, and the recreational character of the area. The goals are not shown in priority order as they are interdependent.

#### 3.1 Water Quality

Crystal Lake is a significant natural resource and it is the desire of property owners, residents, and users of Crystal Lake to maintain or improve the lake's water quality.

#### 3.2 Recreation and Residential Character

The recreational opportunities offered at Crystal Lake should be maintained and enhanced but suited to the lake's particular characteristics and should not detract from the quality of experience at the lake.

Crystal Lake offers a unique setting for part and full time residential use and this quality should be protected and preserved.

Upland development should occur in an appropriate manner to ensure that pollution, noise, or other environmental degradation of the lake and uplands does not take place.

Uses of the lake should be compatible or enhance the present character of the lake which is of a low-impact, quiet recreational character.

### 3.3 Wildlife

The ability of Crystal Lake to remain a migratory bird (loon and grebe) nesting site should be preserved. Recreational use of the lake should be compatible with wildlife nesting.

### 3.4 Access

Legal and physical access to the lake should be assured for all members of the public.

Public access should be properly managed and measures should be developed to maintain its safety, cleanliness, sanitary nature, and to ensure that the area remains open to all.

## 4 **Management Issues, Alternatives, and Recommendations**

The management issues at Crystal Lake were identified by the lake's property owners and residents. This section describes several methods for alleviating problems and provides preferred recommendations. The alternatives were developed through discussions with property owners and residents, and a review of how other lakes in the Borough are managed and how lakes in other states have been managed.

### 4.1 Access

*Management Issue* Presently there are three legal and physical methods of access to Crystal Lake; one on the east side and two on the west side of the lake. Two of the access points consist of easements connecting to the lake. The third access is provided by Tract "A" on the northwest side of the lake. Tract "A" was dedicated to the public as part of the subdivision process. Access to Crystal Lake is necessary for recreation purposes. Access must also be provided to the lake to fulfill the State's legal requirement of providing public access to a public water body. The public's use of the lake's access has created problems, such as overnight camping, litter, and unsanitary conditions.

*Alternatives* When considering management alternatives related to public access, one must remember that legal and physical access is necessary for Crystal Lake in order to comply with Borough and State regulations.

In regards to the public access management, three alternatives present themselves: 1) do nothing, 2) vacate the easements and dedication, or 3) actively manage the public access. The first alternative must be discarded because the lack of management will allow unsanitary conditions to continue. Moreover, doing nothing would also allow environmental degradation to continue. The second

alternative must be eliminated as public access must be maintained to Crystal Lake. The third alternative, active management, could eliminate the present problems by providing members of the public with information about the allowable uses on Crystal Lake as well as by providing personnel to convey this information or report violations.

**Recommendation** Of the three alternatives, the third alternative, active management, is the recommended course of action. The Borough will seek to actively manage the sites by providing public awareness information at the access points to the lake. "No Overnight Camping and No Open Fires" signs should also be placed at the access sites. A weather-protected signboard should be placed at the site to provide information about the lake, birdlife, and general "rules of the area" and could be reviewed by all. The information at the signboard should also identify where nearby overnight camping is permitted.

#### 4.2 Wildlife

**Management Issue** The principle wildlife of concern to Crystal Lake residents and property owners is the retention and protection of loon and grebe nesting sites. Presently the lake has active nests and there is a concern that increased motorized activity on the lake will harm the existing nesting sites. The remainder of this section will discuss alternatives for preserving and protecting the grebe and loon nests.

Loon nesting sites and successful breeding may occur on lakes having development and recreational use if sufficient habitat is available and the nesting sites are not repeatedly disturbed. Loons will nest on shore although islands offer the optimal nest sites. Nesting periods generally begin in late May through late June, however, if a nest is abandoned a loon pair may attempt a new nest and this second nesting period runs through late July. In order to retain and protect the existing nest site, lake users need to become informed of how recreation and development affects loons, as well as avoid the nest site during the critical nesting/mating/rearing periods. While grebes commonly have the same breeding period as loons, grebe nest sites are much different. Grebes prefer to nest on floating objects, typically vegetation.

Nest sites and breeding may be disturbed in a number of ways. Steady activity that comes near a nest site, whether motorized or non-motorized, may cause the nest to be abandoned. High motorized activity near a nest site may cause chick mortality due to separation from the adult or wakes caused by motorized craft may destroy the nest or wash away the eggs. In addition to damaging a nest, activities occurring too close to a nest will cause loons to leave an active nest thereby allowing predators such as gulls and ravens to eat the unprotected eggs or chicks. Discarded mono-filament line presents another threat to loons and other birds as it may entangle birds and chicks and ultimately kill them through

starvation, predation, or by drowning.

*Alternatives* If nothing is done to inform lake users of the sensitivity of loons and grebes to water borne activities and development, active nests will not be found on Crystal Lake in the future. In order to maintain the presence of loons and grebes, it is necessary that some proactive steps be implemented.

*Recommendations* Most individuals will not disturb a nest site if they are informed of its location and the proper behavior when near it. It is recommended that a number of techniques be employed to provide the public with information about loons and grebes. First, existing nests where regular loon or grebe nests have occurred should be encircled by a number of buoys marked with "Loon (or Grebe) Nesting Site - Do Not Approach" placed at least 150 feet (200 feet preferred) from the nest's boundary. Appendix #1 provides an illustration of a low cost, effective buoy. Loon and grebe alert notices and general information about loons should be posted at a weather protected signboard at the lake's access point to inform the public about proper "loon or grebe etiquette" (see Appendix #1).

#### 4.3 Noise

*Management Issue* Crystal Lake has a history of relatively quiet recreational use. Residents and property owners of the area wish to maintain these characteristics of the lake, especially during the summer, evening, and early morning hours. However, at this time residents and property owners do not wish to restrict motorized watercraft.

*Alternatives* Three alternatives may be considered for this management issue; namely: 1) do nothing, 2) prohibit all motorized use, 3) limit the size/power of motors that may be used on the lake, and 4) establish quiet hours to allow motorized use which does not detract from the current use and character of the lake.

The first alternative, "Do Nothing" ignores problems that may be associated with noise. The "Do Nothing" alternative also ignores one of the primary reasons residents and property owners requested that a lake management plan be developed. This alternative is therefore rejected.

The second alternative would prohibit all motorized use of the lake. While this alternative would eliminate noise associated with motors, it would also restrict craft that do not generate noise such as boats with electric motors. A complete ban on motorized use would also eliminate uses that are not associated with the noise problem. Residents and property owners do not presently wish to restrict motorized watercraft.

A third alternative is to establish quiet hours at the lake. The use of quiet hours creates a period of time when motorized use that creates noise and is repetitive in nature is prohibited. Quiet hours also allow use of the lake during the quiet hour period for quiet, unobtrusive, transit of the lake for trolling/fishing.

***Recommendation*** Residents and property owners of the area initiated the lake management planning process, for among other concerns, to protect the existing quiet recreational use of Crystal Lake. It is therefore recommended that quiet hours be established during the hours of 10 p.m. to 8 a.m. Sunday through Saturday.

## 5.0 Implementation

Plans may be implemented in a number of ways but are typically implemented through capital improvement programs and subdivision and zoning ordinances. Within the Borough, residents may also petition for motorized use restrictions on lakes and this ordinance may be used to implement a lake management plan. This ordinance was discussed by Crystal Lake property owners and found not to be needed at this time. Plans may also provide for private implementation through public information campaigns and a list of best management practices that may be used by the public. The problems facing Crystal Lake at this time do not warrant a special zoning or subdivision ordinance nor do they warrant implementation of the Borough's motorized use of lakes ordinance. Therefore, this plan will utilize a combination of public information and best management practices to implement the plan. The Borough should utilize its citation authority for infractions of the recommended management guidelines of this plan. In addition, a lake management ordinance<sup>4</sup> may be adopted containing a general provisions section that provides limited guidelines, e.g., wildlife protection, quiet hours, no-wake zones, and bans on overnight camping. The Crystal area residents and property owners should be contacted to determine whether or not Crystal Lake should be included in such an ordinance. A description of the implementation proposals follow.

***Quiet Hours*** Crystal Lake residents and property owners wish to maintain quiet hours during the summer, evening, and early morning hours. The upland development is predominately residential in character. To protect the shoreline and existing quiet, residential character of the area and recreational use, quiet hours should be imposed on the lake during which no repetitive motorized use creating noise should occur. The recommended quiet hours are 10 p.m. through 8 a.m. Sunday through Saturday.

---

<sup>4</sup> Note: Due to the diversity of lakes in the Borough and the many requests for lake management plans and guidelines that have been received, a Borough-wide ordinance consisting of a general provisions section containing rules for all lakes, e.g., don't litter and a more specific provisions section containing several lake categories with different guidelines ranging from none to several is being considered.



***Loons and Grebes*** To protect loons and grebes, it is recommended that a sign (see Appendix #1) be posted on the existing island having an active loon nest. Further, buoys should be placed a minimum of 150 feet (200 feet preferred) around the island to inform lake users of the nest site. Appendix #1 provides information on buoy construction and placement. Finally, a weather-protected informational signboard should be constructed at the preferred access point and information about lake usage and proper behavior near active loon nests, e.g. "Loon (or Grebe) Alert!" The Crystal area residents and property owners and Borough should cooperate in implementing the loon and grebe protection program. Additionally, the harassment of loons and grebes and other lake related wildlife such as grebes may become subject to fines under the proposed lake management ordinance described above.

The parcels used for lake access should be supervised on a regular basis to prevent overnight camping, blockage, and unsanitary conditions. A weather protected information sign should be placed at public access sites to inform the public about the rules regarding the use of Crystal Lake.

***Trash and Fireworks*** Information should be posted at the information signboard at the public access point informing users to pack out what they pack in. Signs should be erected at the access point stating "No Overnight Camping - Do Not Litter".

Firework displays are illegal without a special permit issued by the Borough Planning Department; never-the-less, individuals generally display fireworks throughout the Borough. Firework displays create two problems, noise from explosions and trash from the fireworks. Firework displays may also start forest fires. The Borough does not have the resources to actively police the illegal use of fireworks and such use is a low priority for the Alaska State Troopers. However, the Borough should advise property owners of the law and inform them to be considerate of their neighbors, avoid polluting the lake with debris, and avoid forest fires and disturbance of waterfowl.

APPENDIX #1



# SIGN FLOAT FOR LOON NESTS

(NOT LIKELY TO TURN OVER  
IN THE STRONGEST WIND)

## AERIAL VIEW

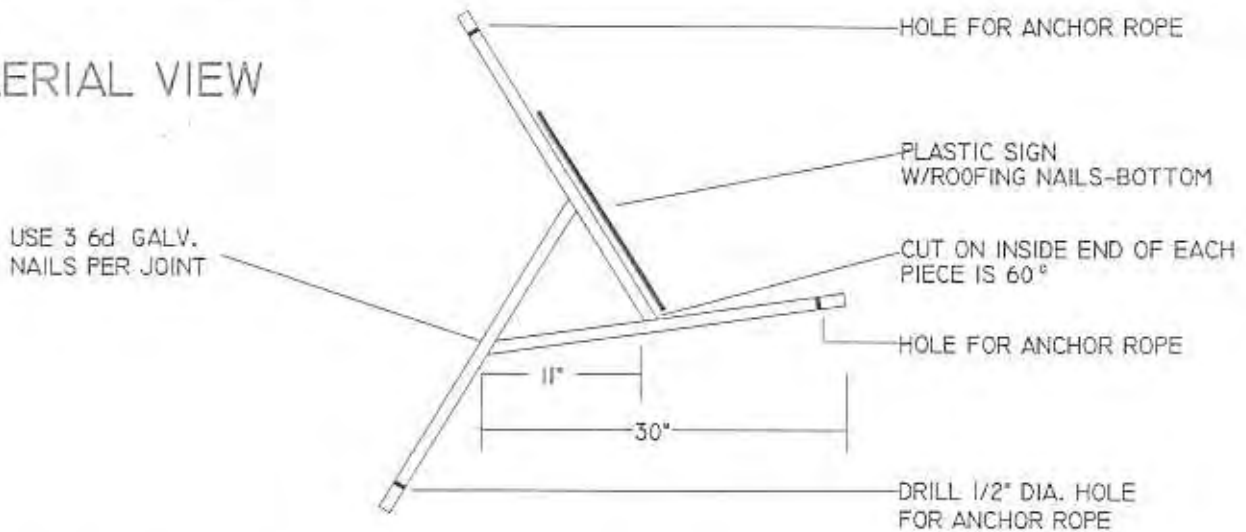

## VIEW FROM WATER

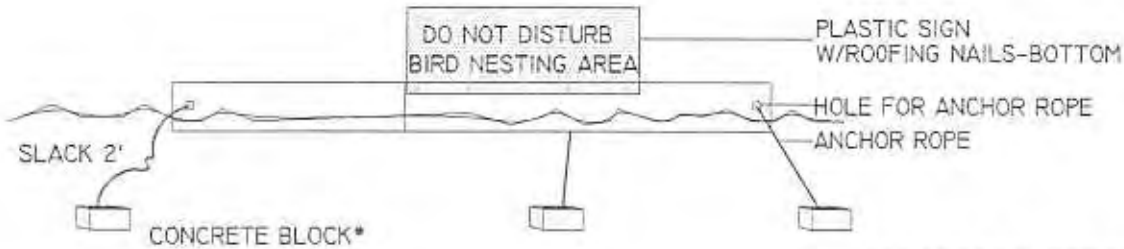

\*GALLON MILK JUGS FILLED WITH SAND  
COULD REPLACE CONCRETE BLOCKS

## NEST

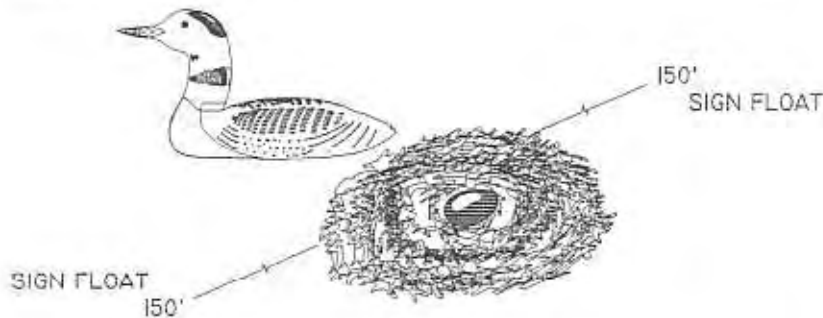

## MATERIALS LIST

- 3 - 1"x 4"x 30"  
WHITE PINE OR  
NO. WHITE CEDAR
- 9 - 6d GALV BOX NAILS
- 5 - 1" ROOFING GALV. NAILS
- 1 - LOON SIGN
- 2 - 3 CONCRETE BLOCK \*  
FOR ANCHORS
- ENOUGH 1/4" NYLON ROPE  
TO REACH BOTTOM OF LAKE  
FOR ANCHOR

The platforms should be attached with two anchors a minimum of 150 feet from the nest (more, if needed to avoid disturbing the loons) and be clearly visible, yet not be a boating hazard. Signs should be removed after nesting is completed (usually by mid-July) each year to preserve their use. Signs should be stored over the winter in a dry area.

# LOON ALERT



**Help keep this lake safe  
for loons and other wildlife:**

1. Watch loons from a distance.
2. Pick up fishing line and other litter that may entangle loons.
3. Keep your dog on a leash.

Breeding loons have declined or disappeared from other U.S. states due to human disturbance and habitat loss. Wildlife harassment is illegal. Please report violations to Fish and Wildlife Protection (State Troopers) or call (800) 478-3377. For loon information write: Alaska Department of Fish and Game, Division of Wildlife Conservation, 333 Raspberry Road, Anchorage, AK 99518.



# STEER CLEAR!

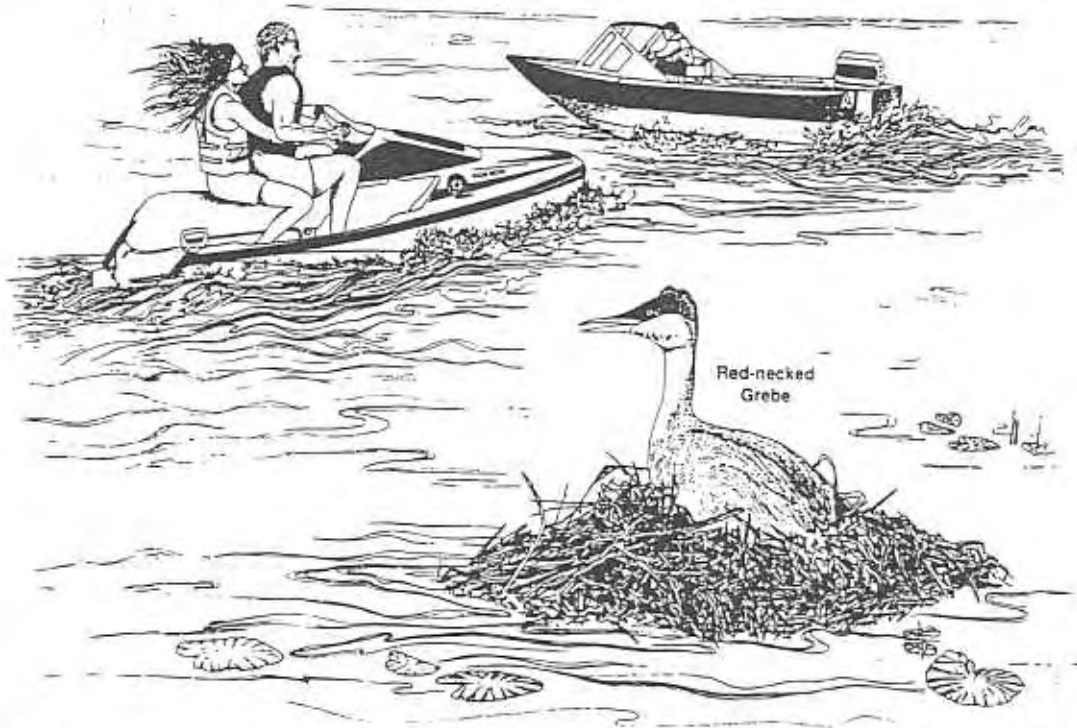

**BOATERS – Stay at least 100 feet away  
from nesting Red-necked Grebes.**

Grebes are duck-sized birds that nest on floating  
vegetation and debris in shallow water.

Wakes from watercraft will destroy their nests and kill  
their eggs and chicks.

Go slowly along shorelines and avoid nesting areas.

**– HELP PROTECT ALASKA'S WILDLIFE –**

Wildlife harassment is illegal. Report violations to Fish and Wildlife  
Protection (State Troopers) or call (800) 478-3377.

This sign was produced by a grant to the Alaska Watchable Wildlife Trust Fund, c/o Alaska  
Conservation Foundation, 430 W. 7th Avenue #215, Anchorage AK 99501 (907) 276-1917.

POSTED BY ALASKA DEPT. FISH AND GAME

